



CUT60NH CUT40NH



Operator's Manual

LINLONG LIMITED
www.weldpro.com

**THANK
YOU**

**for your
purchase!**



Take a moment and subscribe to our youtube channel. Weldpro is committed to releasing lots of tutorial and how-to videos to help you fine tune your welding skill.



Dear Valued customer,

We at Weldpro would like to thank you very much for being our valued customer. We take great pride in providing quality welding equipment at an affordable price.

As an experienced welder, your feedback (no matter positive or negative) will be an important factor for us to improve the quality of our product and our customer service. We would greatly appreciate if you would take a moment to provide feedback for the product that you purchased.

Weldpro is always there to assist you should you have any questions.

Sincerely, your friends at Weldpro!



Linlong Limited

1307 West Valley Highway North, Suite 103, Auburn, Washington 98001
www.weldpro.com Tel:253-329-2179

Technical support: 651 329 2686

Email: support@weldpro.com



IMPORTANT

**For any questions, concerns, or
problems contact Weldpro**



**Support directly at
651-329-2686**

Introduction

This manual contains the description of the hardware and the operating instructions of the equipment. For your safety and that of others, please read this manual carefully.

Attention

Pay attention to the words following the signs below.

Sign	Description
 DANGER	The word following this sign means that there is great potential danger, which may cause a major accident, damage or even death, if the instructions are not followed.
 WARNING	The word following this sign means that there is some potential danger, which may cause bodily injury or property damage, if the instructions are not followed.
 ATTENTION	The word following this sign means that there is potential risk, which may cause malfunctions and/or breakdowns, if the instructions are not followed.

Edition

The contents of this manual are updated regularly in order to include all product updates. The manual is to be used solely as a user's guide, except where indicated otherwise. No warranties of any kind, whether expressed or implied are made in relation to the information, descriptions, suggestions or any other content of the manual.

The images of this manual are for reference only. If there is any inconsistency between the image and the actual product, the actual product will govern.

CONTENTS

- 1 WELDPRO SAFETY 5
- 2 PRODUCT DESCRIPTION 18
- 3 THREE YEARS WARRANTY 19
- 4 TECHNICAL PARAMETERS 20
- 5 INSTRUCTIONS FOR THE INSTALLATION 21
- 6 OPERATING 23
- 7 MAINTENANCE AND TROUBLESHOOTING 25

**For Arc
Welding
and Cutting
like a
Weldpro**



Thank you for using Weldpro arc welding and cutting equipment.

We ask you to work like a weld-pro and weld-pros weld and cut safely. Please read and comply with the sample safety procedures outlined in this guide and the equipment Owner's Manual.



Always read and follow the Owner's Manual, the safety labels on the product, and all applicable safety standards, especially ANSI Z49.1, Safety in Welding, Cutting, (we recommend you get a copy and keep it handy).



Only qualified persons should install, operate, maintain, and repair this equipment. A qualified person is defined as one who, by possession of a recognized degree, certificate, or professional standing, or who by extensive knowledge, training and experience, has successfully demonstrated the ability to solve or resolve problems relating to the subject matter, the work, or the project and has received safety training to recognize and avoid the hazards involved.

Thank you for working safely.

1	General Safe Practices.....	6
2	Arc Welding Hazards.....	6-8
3	Plasma Arc Cutting Hazards.....	9-11
4	Special Situations & Equipment.....	12-13
5	EMF Information.....	13-14
6	California Proposition 65 Warnings.....	14
7	Principal Safety Standards.....	14
8	Lens Shade Selector Guide.....	15
9	Weld Cable Selector Guide.....	16

1. General Safe Practices

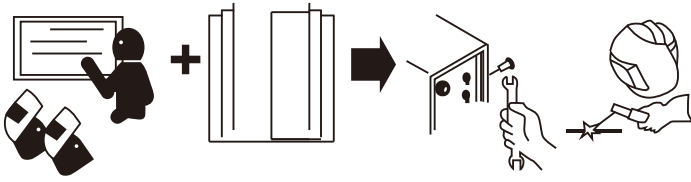

Become trained and read the instructions before working on the machine or welding or cutting. Read and understand the Safety Data Sheets (SDSs) and the manufacturer's instructions for adhesives, coatings, cleaners, consumables, coolants, degreasers, fluxes, and metals.

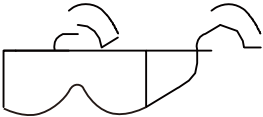

Wear approved safety glasses with side shields under your welding helmet or face shield and at all times in the work area.

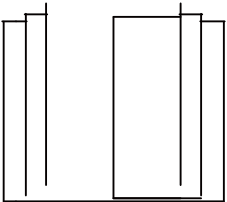

Read and follow all labels and the Owner's Manual carefully before installing, operating, or servicing unit. Read the safety information at the beginning of the manual and in each section.

Wear a safety harness if working above floor level. Keep children away from all equipment and processes.

Do not install or place machine on or over combustible surfaces.

Use GFCI protection when operating auxiliary equipment in damp or wet locations.

Use only genuine replacement parts from the manufacturer.

Perform installation, maintenance, and service according to the Owner's Manuals, industry standards, and national, state, and local codes.

2. Arc Welding Hazards



Electric shock from welding electrode or wiring can kill.

Wear dry, hole-free insulating gloves and body protection. Do not touch electrode with bare hand. Do not wear wet or damaged gloves.

Do not touch live electrical parts.

Do not use AC weld output in damp, wet, or confined spaces, or if there is a danger of falling.

Use AC output ONLY if required for the welding process.

If AC output is required, use remote output control if present on unit. Do not use worn, damaged, undersized, or repaired cables.

Additional safety precautions are required when any of the following electrically hazardous conditions are present: in damp locations or while wearing wet clothing; on metal structures such as floors, gratings, or scaffolds; when in cramped positions such as sitting, kneeling, or lying; or when there is a high risk of unavoidable or accidental contact with the workpiece or ground. For these conditions, use the following equipment in order presented: 1) a semiautomatic DC constant voltage (wire) welder, 2) a DC manual (stick) welder, or 3) an AC welder with reduced open-circuit voltage.

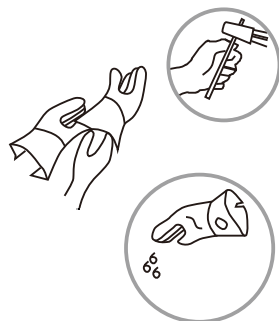

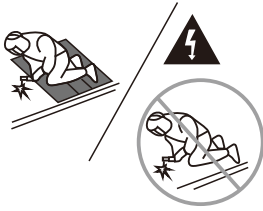

Protect yourself from electric shock by insulating yourself from work and ground. Use non-flammable, dry insulating material if possible, or use dry rubber mats, dry wood or plywood, or other dry insulating material big enough to cover your full area of contact with the work or ground and watch for fire.

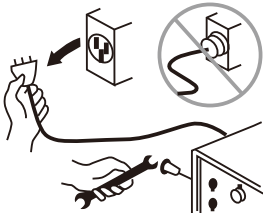

Disconnect input plug or power before working on machine. Do not make input connections if color blind.

Frequently inspect input power cord and ground conductor for damage or bare wiring – replace immediately if damaged – bare wiring can kill. Keep cords dry, free of oil and grease, and protected from hot metal and sparks. Be sure input ground wire is properly connected to a ground terminal in disconnect box or receptacle.

Properly install, ground, and operate all equipment according to its Owner's Manual and national, state, and local codes.



Breathing welding fumes can be hazardous to your health.



Keep your head out of the fumes. Do not breathe the fumes. Use enough ventilation, exhaust at the arc, or both, to keep fumes and gases from your breathing zone and the general area. The recommended way to determine adequate ventilation is to sample for the composition and quantity of fumes and gases to which personnel are exposed.

Read and understand the Safety Data Sheets (SDSs) and the manufacturer's instructions for adhesives, coatings, cleaners, consumables, coolants, degreasers, fluxes, and metals.



Use enough forced ventilation or local exhaust (forced suction) at the arc to remove the fumes from your breathing area.



Use a ventilating fan to remove fumes from the breathing zone and welding area.

If adequacy of ventilation or exhaust is uncertain, have your exposure measured and compared to the Threshold Limit Values (TLV) in the Safety Data Sheet (SDS).

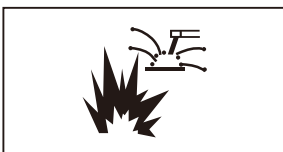

Welding can cause fire or explosion.



Do not weld near flammable material or where the atmosphere can contain flammable dust, gas, or liquid vapors (such as gasoline). Move flammables at least 35 feet (11 meters) away or protect them with flame-proof covers (see NFPA 51B listed in Section.

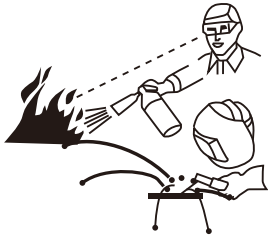

Welding sparks can cause fires. Have a fire extinguisher nearby and have a trained fire watcher ready to use it. After completion of work, inspect area to ensure it is free of sparks, glowing embers, and flames.



Do not weld on containers that have held combustibles, or on closed containers such as tanks, drums, or pipes unless they are properly prepared according to AWS F4.1 and AWS A6.0 (see Safety Standards in Section 9).



Welding can cause fire or explosion.

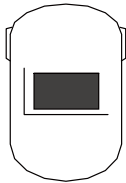

Use welding helmet with correct shade of filter (see Section to choose the correct shade).



Wear welders cap and safety glasses with side shields. Use ear protection when welding out of position or in confined spaces. Button shirt collar.

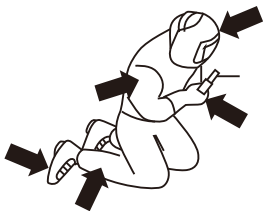

Wear body protection made from durable, flame-resistant material (leather, heavy cotton, wool). Body protection includes oil-free clothing such as leather gloves, heavy shirt, cuffless trousers, high shoes, and a cap.



Moving parts can injure.

Keep hands, hair, loose clothing, and tools away from moving parts such as fans, belts, wire drive rolls, and rotors. Keep all doors, panels, and guards closed and secured.

3. Plasma Arc Cutting Hazards



Cutting sparks can cause fire or explosion.



Do not cut near flammable material or where the atmosphere can contain flammable dust, gas, or liquid vapors (such as gasoline). Move flammables at least 35 feet (11 meters) away or protect them with flame-proof covers (see NFPA 51B listed in Section 9).



Cutting sparks can cause fires. Have a fire extinguisher nearby, and have a trained fire watch ready to use it. After completion of work, inspect area to ensure it is free of sparks, glowing embers, and flames.



Do not cut on containers that have held combustibles, or on closed containers such as tanks, drums, or pipes unless they are properly prepared according to AWS F4.1 and AWS A6.0 (see Safety Standards in Section 9).



Plasma arc can injure.

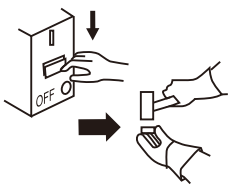

Turn off power before disassembling torch.

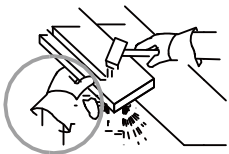

Do not grip material near cutting path.
Do not touch hot parts bare-handed.



Electric shock from torch or wiring can kill.



Wear dry insulating gloves. Do not wear wet or damaged gloves. Do not touch live electrical parts.

Do not use worn, damaged, undersized, or repaired cables.

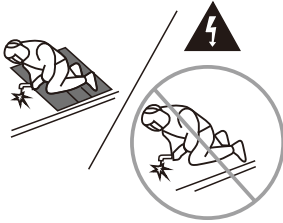

Protect yourself from electric shock by insulating yourself from work and ground. Use non-flammable, dry insulating material if possible, or use dry rubber mats, dry wood or plywood, or other dry insulating material big enough to cover your full area of contact with the work or ground. Watch for fire, smoke, and sparks.

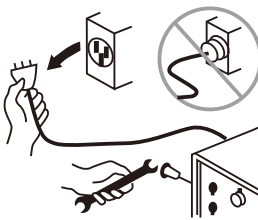

Disconnect input plug or power before working on machine. Do not make input connections if color blind.

Frequently inspect input power cord and ground conductor for damage or bare wiring – replace immediately if damaged – bare wiring can kill. Keep cords dry, free of oil and grease, and protected from hot metal and sparks. Be sure input ground wire is properly connected to a ground terminal in disconnect box or receptacle.

Properly install, ground, and operate this equipment according to its Owner's Manual and national, state, and local codes.



Breathing cutting fumes can be hazardous to your health.



Keep your head out of the fumes. Do not breathe the fumes. Use enough ventilation, exhaust at the arc, or both, to keep fumes and gases from your breathing zone and the general area. The recommended way to determine adequate ventilation is to sample for the composition and quantity of fumes and gases to which personnel are exposed.

Read and understand the Safety Data Sheets (SDSs) and the manufacturer's instructions for adhesives, coatings, cleaners, consumables, coolants, degreasers, fluxes, and metals.

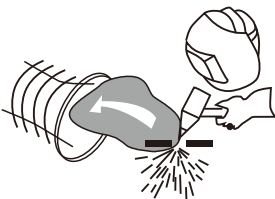

Use enough forced ventilation or local exhaust (forced suction) at the arc to remove the fumes from your breathing area.

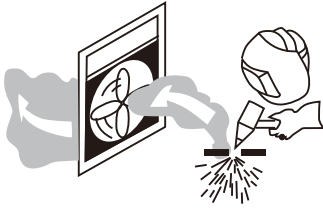

Use a ventilating fan to remove fumes from the breathing zone and cutting area. If adequacy of ventilation or exhaust is uncertain, have your exposure measured and compared to the Threshold Limit Values (TLV) in the Safety Data Sheet (SDS).



Arc rays can burn eyes and skin.

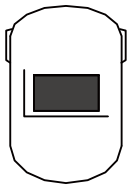

Use welding helmet or face shield with correct shade of filter (see Section to choose the correct shade).



Wear welders cap and safety glasses with side shields. Use ear protection when cutting out of position or in confined spaces. Button shirt collar.

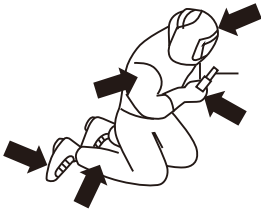

Wear body protection made from durable, flame-resistant material (leather, heavy cotton, wool). Body protection includes oil-free clothing such as leather gloves, heavy shirt, cuffless trousers, high shoes, and acap.

Periodically double-check all nuts and bolts for tightness and condition

Loose or incorrect hardware and fasteners can injure, and damage equipment.

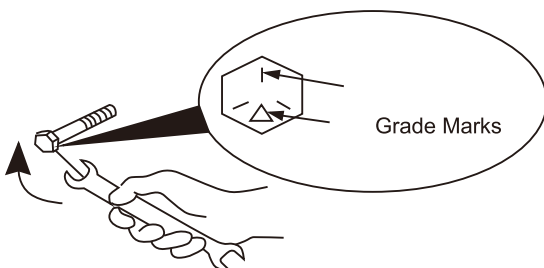

If necessary, always replace any fastener with one of equal size, grade, and type.

Be sure the grade marks on replacement fastener match the original bolt. The manufacturer's identification mark .

4. Special Situations & Equipment



Confined spaces can be hazardous.

Confined spaces are areas which lack room for full movement and often lack ventilation, such as storage tanks, vats, tunnels, boilers, pipes, hold of a ship, corners of a room, near a ceiling or floor corner, or in a pit. Gases can collect and form dangerous concentrations.

Always open all covers, remove any hazardous or toxic materials, provide forced ventilation, and provide a means to turn off power and gas from the inside.

Never work alone — have constant communication with someone outside who can quickly turn off power and gas, is trained in rescue procedures, and is able to pull you out in case of emergency.

Do not use AC weld output in confined spaces.

Insulate yourself from work and ground using non-flammable, dry insulating material if possible, or use dry rubber mats, dry wood or plywood, or other dry insulating material big enough to cover your full area of contact with the work or ground, and watch for fire.

Always check and monitor the air quality in the space. Welding or cutting fumes and gases can displace air and lower the oxygen level — use ventilation and, if needed, an air-supplied respirator. Be sure the breathing air is safe. The recommended way to determine adequate ventilation is to sample for the composition and quantity of fumes and gases.

Always remember: All normal arc welding and cutting hazards are amplified in confined spaces. See ANSI Z49.1 listed in Principal Safety Standards (Section 9).



Cylinders can explode if damaged.

Confined spaces are areas which lack room for full movement and often lack ventilation, such as storage tanks, vats, tunnels, boilers, pipes, hold of a ship, corners of a room, near a ceiling or floor corner, or in a pit. Gases can collect and form dangerous concentrations.

Always open all covers, remove any hazardous or toxic materials, provide forced ventilation, and provide a means to turn off power and gas from the inside.

Never work alone — have constant communication with someone outside who can quickly turn off power and gas, is trained in rescue procedures, and is able to pull you out in case of emergency.

Do not use AC weld output in confined spaces.

Insulate yourself from work and ground using non-flammable, dry insulating material if possible, or use dry rubber mats, dry wood or plywood, or other dry insulating material big enough to cover your full area of contact with the work or ground, and watch for fire.

Always check and monitor the air quality in the space. Welding or cutting fumes and gases can displace air and lower the oxygen level — use ventilation and, if needed, an air-supplied respirator. Be sure the breathing air is safe. The recommended way to determine adequate ventilation is to sample for the composition and quantity of fumes and gases.

Always remember: All normal arc welding and cutting hazards are amplified in confined spaces. See ANSI Z49.1 listed in Principal Safety Standards (Section 9).

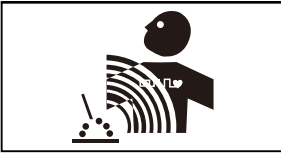

Electric and magnetic fields (EMF) can affect Implanted Medical Devices.

Wearers of Pacemakers and other Implanted Medical Devices should keep away. Implanted Medical Device wearers should consult their doctor and the device manufacturer before going near arc welding, spot welding, gouging, plasma arc cutting, or induction heating operations.



Hot parts can burn.

Do not touch hot welded or cut parts with bare hand. If handling is needed, use proper tools and/or wear heavy, insulated welding gloves to prevent burns. Allow cooling period before handling parts or working on equipment.



Falling equipment can injure, and damage equipment.

Use lifting eye to lift unit only, NOT running gear, gas cylinders, trailer, or any other accessories. Use correct procedures and equipment of adequate capacity to lift and support unit. If using lift forks to move unit, be sure forks are long enough to extend beyond opposite side of unit. Do not place unit where it can easily tip over or fall.

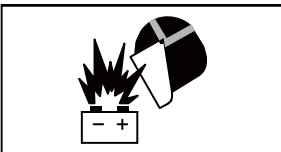

Battery charging output and battery explosion can injure.

Sparks can cause battery gases to explode. Do not smoke and keep matches and flames away from battery. Wear a face shield or safety glasses when working near or on a battery. Do not use welder or plasma cutter to charge batteries or jump start vehicles unless the unit has a battery charging feature designed for this purpose.

5. EMF Information

Electric current flowing through any conductor causes localized electric and magnetic fields (EMF). The current from arc welding (and allied processes including spot welding, gouging, plasma arc cutting, and induction heating operations) creates an EMF field around the welding circuit. EMF fields can interfere with some medical implants, e.g. pacemakers. Protective

measures for persons wearing medical implants have to be taken. For example, restrict access for passers-by or conduct individual risk assessment for welders. All welders should use the following procedures in order to minimize exposure to EMF fields from the welding circuit:

1. Keep cables close together by twisting or taping them or using a cable cover.
2. Do not place your body between welding cables. Arrange cables to one side and away from the operator.
3. Do not coil or drape cables around your body.
4. Keep head and trunk as far away from the equipment in the welding circuit as possible.
5. Connect work clamp to workpiece as close to the weld as possible.
6. Do not work next to, sit or lean on the welding power source.
7. Do not weld whilst carrying the welding power source or wire feeder.

About Implanted Medical Devices:

Implanted Medical Device wearers should consult their doctor and the device manufacturer before performing or going near arc welding, spot welding, gouging, plasma arc cutting, or induction heating operations. If cleared by your doctor, then following the above procedures is recommended.

6. California Proposition 65 Warnings



WARNING: The machine is mainly used for industrial purpose. It will cause radio interference indoor, operators shall take fully preventative measures.

For more information, go to www.P65Warnings.ca.gov.



WARNING: Cancer and Reproductive Harm – www.P65Warnings.ca.gov.

For Diesel Engines:



WARNING: Breathing diesel engine exhaust exposes you to chemicals known to the state of California to cause cancer and birth defects or other reproductive harm.

- Always start and operate the engine in a well-ventilated area.
- If in an enclosed area, vent the exhaust to the outside.
- Do not modify or tamper with the exhaust system.
- Do not idle the engine except as necessary.

For more information, go to www.P65Warnings.ca.gov.

7. Principal Safety Standards

Safety in Welding, Cutting, and Allied Processes, American Welding Society standard ANSI Standard Z49.1. Website: www.aws.org.

Safe Practices for the Preparation of Containers and Piping for Welding and Cutting, American Welding Society Standard AWS F4.1 from Global Engineering Documents.

Website: www.global.ihs.com.

Safe Practices for Welding and Cutting Containers that have Held Combustibles, American Welding Society Standard AWS A6.0 from Global Engineering Documents.

Website: www.global.ihs.com.

National Electrical Code, NFPA Standard 70 from National Fire Protection Association. Website: www.nfpa.org and www.sparky.org.

Safe Handling of Compressed Gases in Cylinders, CGA Pamphlet P-1, from Compressed Gas Association. Website: www.cganet.com

8. Lens Shade Selector Guide

Operation/Process	Electrode Size in. (mm)	Arc Current (Amperes)	Minimum Protective Shade	Suggested* Shade No. (Comfort)
Shielded metal arc welding (SMAW)	Less than 3/32 (2.5)	Less than 60	7	—
	3/32–5/32 (2.5–4)	60–160	8	10
	5/32–1/4 (4–6.4)	160–250	10	12
	More than 1/4 (6.4)	250–550	11	14
Gas metal arc welding (GMAW) and flux cored arc welding (FCAW)		Less than 60	7	—
		60–160	10	11
		160–250	10	12
		250–550	10	14
Gas tungsten arc welding (GTAW)		Less than 50	8	10
		50–150	8	12
		150–500	10	14
Air carbon arc cutting (CAC–A)	(Light)	Less than 500	10	12
	(Heavy)	500–1000	11	14
Plasma arc welding (PAW)		Less than 20	6	6 to 8
		20–100	8	10
		100–400	10	12
		400–800	11	14
Plasma arc cutting (PAC)		Less than 20	4	4
		20–40	5	5
		40–60	6	6
		60–80	8	8
		80–300	8	9
		300–400	9	12
		400–800	10	14
Torch brazing (TB)		—	—	3 or 4
Torch soldering (TS)		—	—	2
Carbon arc welding (CAW)		—	—	14
	Plate thickness			
	in.	Mm		
Oxyfuel gas welding (OFW)	Light	Under 3.2		4 or 5
	Medium	3.2 to 12.7		5 or 6
	Heavy	Over 12.7		6 or 8
Oxygen Cutting (OC)	Light	Under 25		3 or 4
	Medium	25 to 150		4 or 5
	Heavy	Over 150		5 or 6

As a rule of thumb, start with a shade that is too dark to see the weld or cut zone. Then go to a lighter shade which gives sufficient view of the weld or cut zone without going below the minimum. In oxyfuel gas welding, cutting, or brazing where the torch produces a high yellow light, it is desirable to use a filter lens that absorbs the yellow or sodium line in the visible light of the (spectrum) operation.

Guide adapted from ANSI Z49.1, 2012.

9. Weld Cable Selector Guide

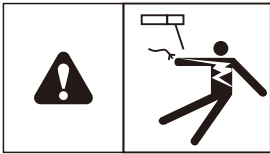

 Turn Off power before connecting to weld output terminals.

 Do not use worn, damaged, under- sized, or repaired cables.

NOTICE : The Total Cable Length in Weld Circuit (see table below) is the combined length of both weld cables. For example, if the power source is 100 ft (30 m) from the workpiece, the total cable length in the weld circuit is 200 ft (2 cables x 100 ft). Use the 200 ft (60 m) column to determine cable size.

Welding Amperes	Weld Cable Size** And Total Cable (Copper) Length In Weld Circuit Not Exceeding			
	100 ft (30 m) Or Less		150 ft / (45 m)	200 ft / (60 m)
	10 – 60% Duty Cycle AWG (mm2)	60 – 100% Duty Cycle AWG (mm2)	10 – 100% Duty Cycle AWG (mm2)	
100	4 (20)	4 (20)	4 (20)	3 (30)
150	3 (30)	3 (30)	2 (35)	1 (50)
200	3 (30)	2 (35)	1 (50)	1/0 (60)
250	2 (35)	1 (50)	1/0 (60)	2/0 (70)
300	1 (50)	1/0 (60)	2/0 (70)	3/0 (95)
350	1/0 (60)	2/0 (70)	3/0 (95)	4/0 (120)
400	1/0 (60)	2/0 (70)	3/0 (95)	4/0 (120)
500	2/0 (70)	3/0 (95)	4/0(120)	2x2/0 (2x70)
600	3/0 (95)	4/0 (120)	2x2/0 (2x70)	2x3/0 (2x95)
700	4/0 (120)	2x2/0 (2x70)	2x3/0 (2x95)	2x4/0 (2x120)
800	4/0 (120)	2x2/0 (2x70)	2x3/0 (2x95)	2x4/0 (2x120)
900	2x2/0 (2x70)	2x3/0 (2x95)	2x4/0 (2x120)	3x3/0 (3x95)
1000	2x2/0 (2x70)	2x3/0 (2x95)	2x4/0 (2x120)	3x3/0 (3x95)
1250	2x3/0 (2x95)	2x4/0 (2x120)	3x3/0 (3x95)	4x3/0 (4x95)

* This chart is a general guideline and may not suit all applications. If cable overheating occurs (normally you can smell it), use next size larger cable.

** Weld cable size (AWG) is based on either a 4 volt or less drop or a current density of at least 300 circular mils per ampere.

*** For distances longer than those shown in this guide, see AWS Fact Sheet No. 39, Welding Cables, available from the American Welding Society at <http://www.aws.org>.

PRODUCT DESCRIPTION

Congratulations on your purchase.

CUT40NH/60NH is equipped with the most internationally advanced inverter technology. First the 60Hz frequency is inverted to a higher frequency (a frequency over 100KHz) by the V-MOSFET. Then the voltage is reduced, the current is commuted, and the inverter power supply generates powerful DC plasma current using the PWM technology. As reversed power technology is used, the volume and the weight of the main transformer has been reduced substantially and its efficiency has been increased by 30%.

The pilot arc system can start easily using the principle of blowback design. This is a mechanical process that moves the electrode off its seat with air pressure. High frequency points are not needed. Its features also allow to supply gas ahead of cutting stream and gas shut off delayed after cut to cool consumables.

The cutting machine has the following characteristics:

1. Stability.
2. Reliability.
3. Lightness.
4. Energy saving and noise-free.
5. High cutting speed.
6. Cuts smoothly, no polishing needed.

The cutting machine can be used widely; it is suitable for cutting stainless steel, alloy steel, mild steel, copper and other color metal materials.

THREE YEARS WARRANTY

WELDPRO Warranty and Return Terms
Welders and Plasma Cutters

All Weldpro welders and plasma cutters are covered under the following specific terms of warranty. All welders and plasma cutters are warranted to the original purchaser only, when purchased through an authorized seller of Weldpro products for a period of three (3) years from the date of purchase, to be free of manufacturers defect or failure. Proof of purchase and date of purchase paperwork will be required by Weldpro at the time of the claim.

Extended warranty coverage may be available for Weldpro welders and plasma cutters at an additional cost. Always check with Weldpro.

The Weldpro warranty is limited to defects, malfunctions or failure of the equipment to operate properly based specifically and solely from manufacturer defects. Any malfunctions from improper use, lack of maintenance, incorrect or insufficient source supply power to the units, shipping damage, and similar failures not related to specific manufacturers defect will not be honored.

Weldpro will not be responsible in the event of a product failure, for lost time in operation or use of said product. Rather it will honor solely the product itself only.

Further, the warranty will cover the repair or replacement of the unit in question for the term of the warranty with either a new or a refurbished unit, or in some cases replacement parts of the same model, at the discretion of Weldpro. As a term of the Weldpro warranty, if and when applicable, individual parts are needed, they may be supplied to the customer rather than replacing the entire unit. Situations like this may include, but are not limited to items such as foot pedals, torches, mig wire rollers, feed spools, or any other item Weldpro deems more practical to supply individually.

Weldpro will provide free shipping return of the damaged product due to manufacturers defect for the first 30 days of the warranty term if shipping is within the lower 48 United States. Customers outside this area must check with Weldpro for further shipping instructions. Failures after the initial 30-day period, and due to manufacturers defect, may not enjoy free return shipping.

If it is determined when the product is returned to Weldpro that there is no malfunction, or that the assumed malfunction by the customer was user error, Weldpro may request a shipping fee refund prior to the return of the item to the customer.

Prior to returning any item thought to be malfunctioning or damaged due to manufacturers defect, customers are required to contact Weldpro first, to explain the failure and to obtain a Return Merchandise Authorization number, or the item may not be covered under the terms of this warranty.

Weldpro ships in the USA from third party shippers such as, but not limited to UPS, FedEx, and the USPS. Weldpro is not responsible for damage that occurs during shipping. It is the customer's responsibility to check the item at the time of delivery. If a customer receives an item damaged, they must immediately contact both Weldpro and the shipper to document and report the damage as soon as possible, and in no circumstances later than 48 hours after delivery. All shipping and delivery dates are tracked for arrival. Weldpro may require photo image of the damage at their discretion.

Returned items within the first 30 days. Undamaged items in good working condition may be returned within the first 30 days of purchase. In such a case, these items are not eligible for the free return shipping policy associated with items that have manufacturers defects. A restocking fee will be charged for said return of up to 25% on any item returned with a valid RMA number that are undamaged and not covered or subject under the terms of this warranty. The amount of the restocking fee is solely at the discretion of Weldpro and based on the condition of the returned item and its accessory parts and packaging. Further, should Weldpro receive an item in good working condition that has sustained physical damage, Weldpro has the right to refuse acceptance of said returned item completely, and the customer will be responsible for return shipping of the product to them.

Weldpro does not imply or suggest any interpretation of the above warranty beyond what is stated in this print of its terms.

Weldpro is not responsible for injury due to improper use of the equipment or failure to heed all of the safety precautions associated with the dangers of welding or cutting metals.

The terms and conditions of the Weldpro warranty are subject to change without notice. Be sure to check the terms of the Weldpro warranty prior to your purchase.

TECHNICAL PARAMETERS

Parameters	Model		CUT40NH		CUT60NH	
Supply voltage (V)	1 phase	1 phase	115V±15%	230V±15%	1 phase	1 phase
Frequency (Hz)	50/60					
Rated input current (A)	41.1	28.6	41.1	46.4		
Open circuit voltage (V)	266					
Output current (A)	15-30	15-40	20-30	20-60		
Output voltage (V)	92	96	92	104		
Duty cycle (%)	60					
Power factor	≥ 0.73					
Efficiency (%)	≥ 80					
Arc starting mode	Non-HF, non-contact arc starting					
SCFM requirements	4.1 scfm at 70 psi			3.9 scfm at 70 psi		
Pressure of the air compressor (psi)	50.7-58			50.7-65.3		
Nozzle orifice - inside (in)	.038			.038		
Cutting thickness (in)	.39	.55	.39	.79		
Housing protection class	Ip21					
Insulation class	F					
Cooling method	Fan-cooled					
Weight (lb)	20.3			33.5		
Dimensions (in)	16.5x6.7x12.4			20.1x8.1x15		

INSTRUCTIONS FOR THE INSTALLATION

Power cord plug connection (please find installation diagram enclosed)

1. Each machine has been equipped with a power cable which must be connected to the corresponding voltage class according to the input voltage of the cutting machine. If the cutting machine powered by voltage of 115V or 230V is connected to 400VAC, the inside components of the machine may burn out.
2. Ensure that the power cord is properly connected to the power switch to prevent oxidation.
Make sure that the supply voltage is within the specified range.

Connecting the cables to the machine

1. Ensure that the high-pressure tube of the compressed air is connected firmly to the copper connector.
2. Ensure that the copper screw at the opposite end of the plasma torch is securely connected to the gas electric integrated terminal, then tighten clockwise (to prevent gas leakage). The mobile plug (dinse) at one end of the grounding cable must be connected to the positive terminal on the front panel, and snugged clockwise.
3. Ensure that all torch cable connectors are connected to their respective plugs on the face of the plasma cutter connectors on the front panel. (For cutters with pilot arc, the pilot arc cable of cutting torch must be connected to the terminal of the pilot arc wiring column.)

CHECK-LIST BEFORE OPERATION

1. Ensure that the cutting machine is properly grounded.
2. Ensure that all connectors are connected firmly.
3. Ensure that the power voltages are correct.

OPERATING THE EQUIPMENT

1. Flip the power switch on front pane in the "on" position. The indicator light of power switch must come on. The front panel should show the machine's electrical current volume.
2. Adjust the gas / air pressure making sure it is adequate for the machine, then open the valve of the compressed air. Keep inlet pressure at or about 100psi. Extreme inlet pressure is not necessary considering outlet pressures should not have to exceed 60 or 70 psi.
3. Press the control button of the plasma torch. The mechanical blowback electrode activates, the sound of the arc is audible and there is gas coming out of the plasma torch. (The burner of the pilot arc cutter should spurt fire.)
4. Ensure that the cutting current is adequate for the machine according to the thickness of workpiece.
5. Leave approximately 1 to 2mm between the copper tip and workpiece.

Installation drawing for the CUT60/40Hsv

CUT40NH

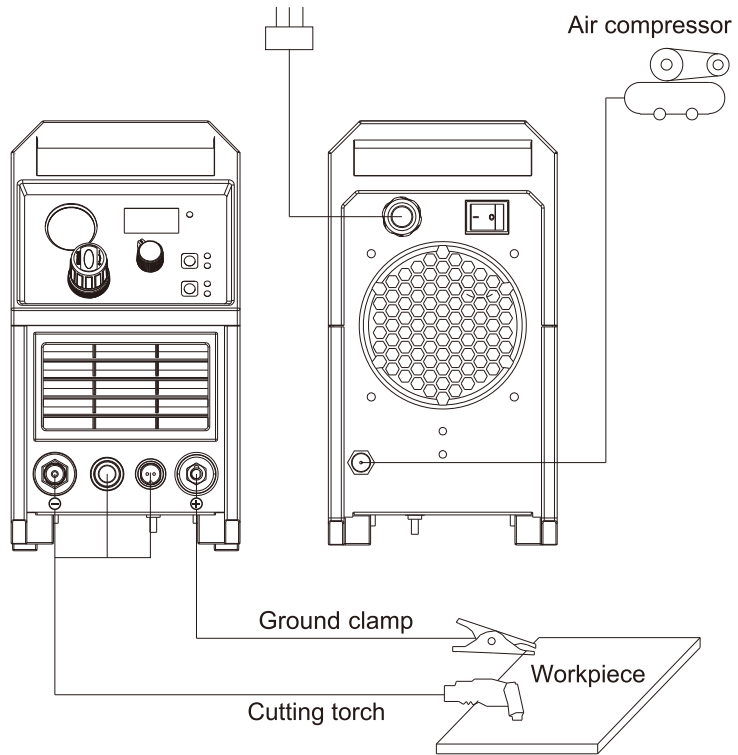

CUT60NH

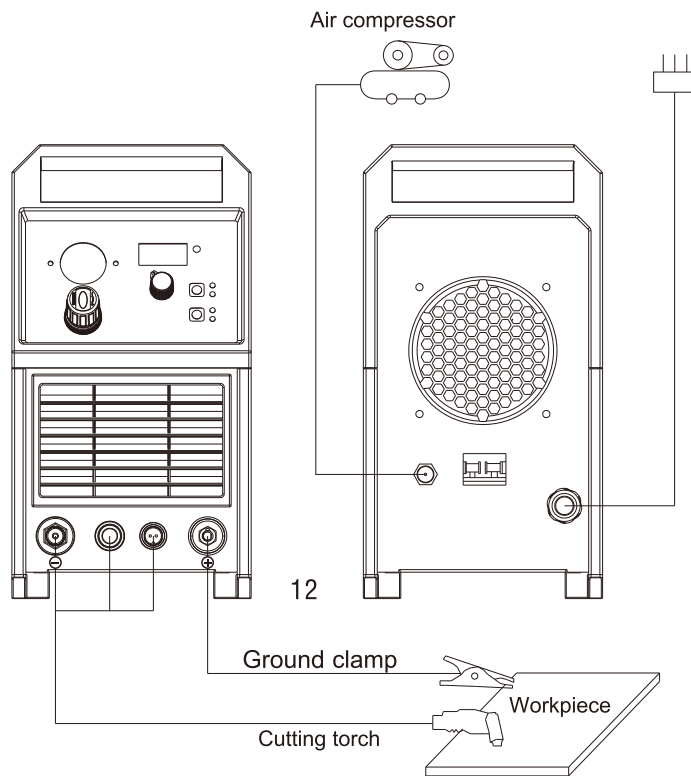

OPERATION

CUT40NH

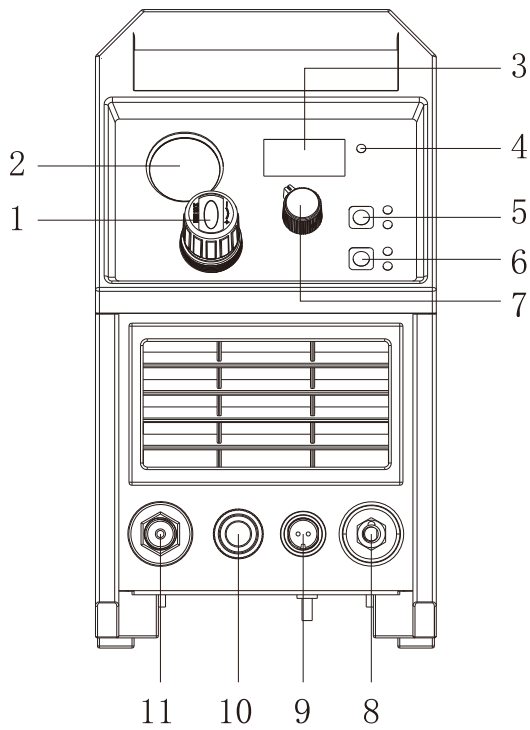

CUT60NH

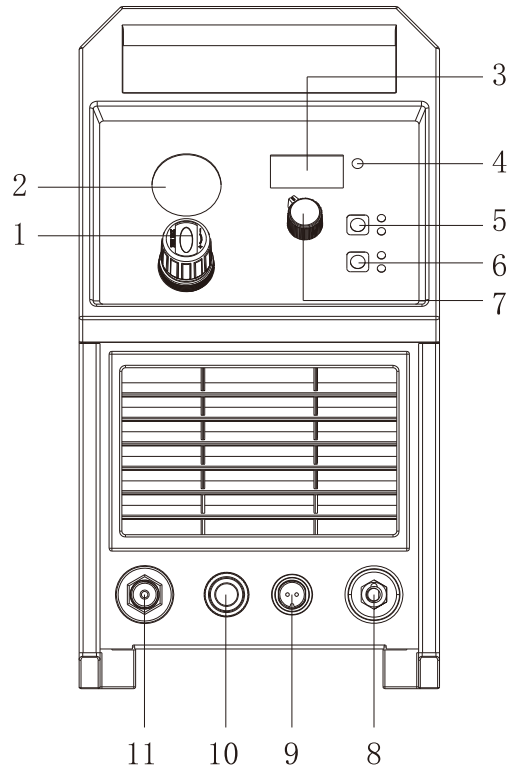

1	Pressure adjustment knob	7	Current adjustment knob
2	Pressure meter display	8	Positive outlet
3	Current meter	9	Socket of the torch switch
4	Fault indicator	10	Pilot arc outlet
5	Gas/ON control switch	11	Gas electric system outlet
6	2T/4T control switch		

The panel pictures above are for reference only. If there is any inconsistency between the image and the actual machine, the actual machine will govern.

OPERATING INSTRUCTIONS

1. Operating environment

1. The cutting machine can be used in environments with harsh weather conditions and with outside temperatures between 14 and 104 degrees Fahrenheit with an air humidity level of max. 80%.
2. Avoid using the equipment under direct sunlight and rain.
3. Keep the machine dry and avoid any contact with water.
4. Do not use the cutting machine in environments polluted with high concentration of dust or corrosive gases.

2. SAFETY

1. Ensure that the work area is adequately ventilated.
The cutting machine is light and compact, it works with high current which generates electromagnetic fields. Natural airflow is not sufficient to cool down the components. There is a axial fan in the interior of the machine as a refrigeration system.

Note : The exhaust shutter must never be blocked or covered, keep a distance of 11.8" between the machine and other objects. Ensure a well ventilated environment to avoid damages to the equipment.

2. Do not overload!
Never exceed the maximum allowable current in any kind of duty cycle.
Do not put excess workload on the equipment to avoid shortening its lifetime or damaging it.
3. Avoid surging!
The input voltage of the cutting machine must match the ranges provided on the main technical data sheet. The automatic voltage compensation circuit will prevent from exceeding the allowable range. If the input voltage is too high, that may damage components. Use with care.
4. There is a grounding screw on the back side of the cutting machine. To avoid electric leakage and static electricity, ensure that the enclosure is connected to the ground with a cable, which has a cross sectional area of at least 10 AWG.
5. If the machine is overused, the overheat protection activates. This will cause the cutting machine to suddenly stop working and a red indicator light will come up. Do not disconnect from the power supply, so that the fan may continue working in order to cool down the machine. Once the temperature is reduced to the allowable range, the machine can be operated again.

3. NOTES ON CUTTING

1. Ensure that the copper tip is not in direct contact with the workpiece while cutting. Incline the cutting torch and leave a distance of 0.04" between the inside orifice of the copper tip and the workpiece to prevent damages to the copper tip. Cutting speed can be metered by watching the direction of the generated sparks under your work, they should bend just slightly away from you to straight down. As you reach the end of your cut, lift the handle of the torch slightly up to allow the plasma arc to change direction slightly toward you to terminate the cut cleanly.
2. If the arc generated by the cutting machine is too weak, or can't be generated, remove the accumulated oxide layer from the electrode using sanding paper. After this the machine can be operated again as usual.

MAINTENANCE AND TROUBLESHOOTING

Maintenance:

1. Remove dust regularly using compressed air. If the cutting machine is used in an environment polluted with smoke and/or dust, dust must be removed from the machine every day.
2. The air pressure must be appropriate to avoid damages to the small components.
3. Check the electrical sockets and ensure that the connectors are connected firmly (especially the components of the connectors and the inserted components). Tighten the connectors, if necessary.
4. Prevent water from entering the machine and the machine from getting wet at all times. If the machine becomes damp, it must be dried and the insulation must be measured by a meter. Once the issue is resolved, the machine can be operated again.
5. If the machine will not be in use for a longer period of time, it should be placed in its own package and stored in a dry environment.

Troubleshooting:

Fault description	Measures to take
1. The indicator light of the interrupter is on, the fan is not working and control switch is not responding.	1. The surge protector is working. Turn off the machine then, after several minutes turn it on again.
2. The indicator light of the interrupter is on and the fan is working. However, when pressing the control switch of the cutting torch, the electromagnetic valve is not working.	<ol style="list-style-type: none"> 1. Ensure that the cutting torch is connected to an open circuit. 2. Ensure that the control switch of the cutting torch is not damaged. 3. The component of auxiliary power supply on the 40NH power board or 60NH control board is damaged and there is no 24VDC output.
3. The machine works properly, but no arc is generated.	<ol style="list-style-type: none"> 1. Input voltage is too low. 2. The pressure of air compressor is too high or too low.



LINLONG LIMITED

www.weldpro.com